

Polymer-tech Solution™

PLASTIC BEARINGS TECHNOLOGY

工程塑料轴承



CSB®



- 成立于1995年，总注册资本7500万人民币；
- 2016年销售额超过4亿元人民币，员工800名；
- 拥有两个生产基地，占地130000m²；
- 国家级高新技术企业，51项专利；
- ISO9001:2008、IATF16949:2016质量认证。
- CSB was established in 1995 and its legal registered capital is 11.5 million US Dollars.
- CSB turnover in 2016 was more than USD 62 million. Currently there are 800 employees working at CSB.
- There are 2 facilities covering over 130000m² with extendable area for future enlargement.
- China National Hi-Tech Enterprise has been granted, 51 patents obtained till now.
- ISO9001: 2008 and IATF16949:2016 quality management system were certificated.

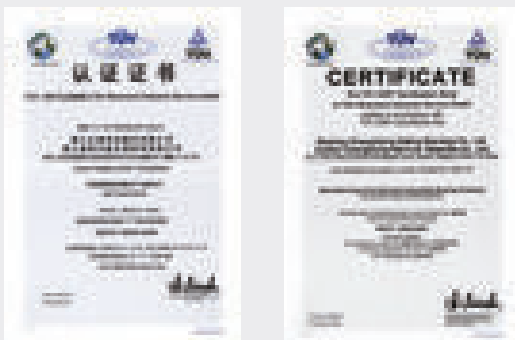

新型自润滑材料适应环境保护要求 Concern for Environment Requirement

CSB积极应对环境保护的要求，通过多年的努力在各个应用领域都已成功开发了满足RoHS要求的不同材料。

Concern for environmental requirement, CSB has developed various kinds of self-lubricating materials to conform to environment requirement.

RoHS指令限制的六种有害物质 EC Directive 2011/65/EU (the RoHS Directive)

汞Hg、六价铬Cr⁶⁺、铅Pb、镉Cd、多溴联苯醚PBDE、多溴联苯PBB。

This directive restricts the use of hazardous substances. Listed below are CSB products which are all RoHS compliant.



"CSB", "Ploymer-tech Solution", "Dry Motion-tech", "Dry-idea", "CSB-EPB", "CSB-LIN", "CSB-FWB", "CSB-LMS", "CSB-BAL", "CSB-RPM", "CSB-PEC", "CSB-PCC", "CSB-PEW", "CSB-PPR", "CSB-FLB", "CSB-CPB", "CSB-PCB", "CSB-PYB", "CSB-SRB" and "CSB-PRB" are legally protected trademarks in China and in case also in foreign countries. 中国保护商标，同时在其它一些国家也受当地法律保护。

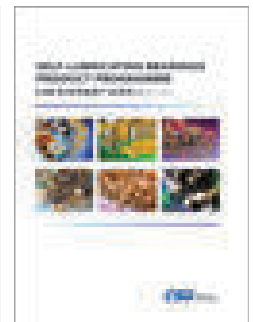
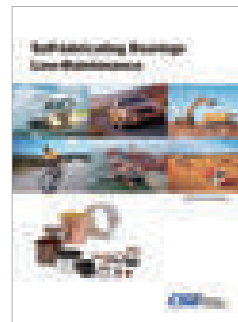
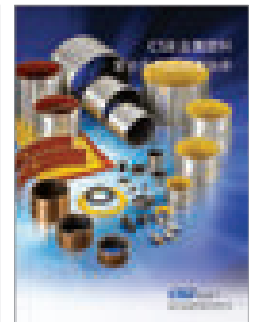

Your Partner for Self-lubricating Bearing Application

为所有工业提供各种自润滑轴承解决方案



CSB-EPB™工程塑料轴承 Plastic Plain Bearings

自润滑免维护、耐腐蚀、长服务寿命、轻量化；可选：极低摩擦系数、高载荷、抗静电、高温250℃、FDA食品安全等级。

Maintenance-free dry operation, Absolute corrosion resistance, Long service time and light; Multiple choices: Lowest friction coefficient, High load, Anti-static, High temperature 250℃, FDA food safety grade.

P12



CSB-BAL™塑料关节轴承 Plastic Spherical Bearings

自润滑免维护、耐腐蚀、抗污垢、轻量化；可选：多种结构设计满足不同安装需求。

Self-lubricating and maintenance-free, Corrosion-resistant, Anti-fouling, lightweight; Multiple structural design to meet different installation requirements.

P168



CSB-LIN™塑料直线轴承 Plastic Linear Bearings

干运行无需供油、抗粉尘、无噪音、耐腐蚀、长服务寿命、轻量化；可选：高温250℃、多种安装方式。

Dry operation without oil, Anti-dust, No noise, Corrosion resistance, Longer service time and light; Multiple Assemble types, Highest operation temperature 250℃.

P186



CSB-LMS™直线驱动系统 Linear Motion Systems

自润滑免维护直线驱动系统，直线滑动原件及丝杆螺母均采用高耐磨EPB13材料制成，实现永久性干摩擦，低噪音、长服务寿命，适合在粉尘或污水下运行。

Self-lubricating and maintenance-free linear motion system, Linear slider and screw nuts are made of high wear-resistant material EPB13, Dry operation for longer time, lower noise, longer service time and suitable for operation in dust or dirty water.

P223



CSB-SFP™耐磨半成品 Semi-finished Products

采用CSB-EPB高耐磨材料制成，可实现非标轴承的快速加工、小批量制作降低成本；可选：棒材、板材、片材。

The semi-finished products are made of anti-wear and high performance materials CSB-EPB, It can be machined non-standard bearings in short time, saving cost for small quantity; Multiple choices: Bar, sheet and tribo-tape.

P281



CSB-PRB™塑料滚动轴承 Plastic Rolling Bearings

自润滑免维护、耐腐蚀、轻量化；可选：内外圈、保持架、滚珠多种材料可选。

Maintenance-free, corrosion-resistant, lightweight; Multiple choices: inner and outer ring, cage and ball can be designed different materials freely.

P291



CSB-SRB™回转支承轴承 Slewing Ring Bearings

免维护干运行、低噪音、轻量化；滑动原件可选耐磨材料EPB13、高载荷金属与特氟龙复合材料CSB-11。

Maintenance-free and dry operation, lower noise, lightweight; The slider can be made of wearresistant material EPB13 or metal and teflon composite material CSB-11 for higher load.

P299



CSB-FWB™纤维缠绕轴承 Filament-wound Bearings

连续长纤维复合材料、干摩擦性能最优越、极高的承载能力、最高静载荷240MPa，特别适合用于高载低速下的摆动。

Long fiber composite material, The best performance for dry operation, High load capacity and max. static load 240MPa, Especially suitable for swing with high load and low speed.

P303

<http://www.csb-ep.com>

Products

CSB-EPB™

www.csb-ep.com
sales@csb-ep.com

Tel: 0086 573 84186133/84185527
Fax: 0086 573 84185517

CSB Product Family

CSB产品

Polymer-tech Solution™

Products

www.csb-ep.com
sales@csb-ep.com
Tel: 0086 573 84186133/84185527
Fax: 0086 573 84185517

CSB-EPB™工程塑料轴承 Plastic Plain Bearings P 12-167



CSB-LIN™塑料直线轴承 Plastic Linear Bearings P 186-222



CSB-PRB™塑料滚动轴承 Plastic Rolling Bearings P 291-294



CSB-BAL™塑料关节轴承 Plastic Spherical Bearings P 168-185

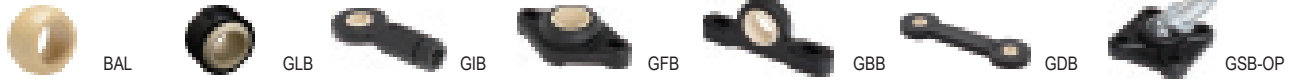

CSB-LMS™直线驱动系统 Linear Motion Systems P 223-280



CSB-SRB™回转支撑轴承 Slewing Ring Bearings P 299-302

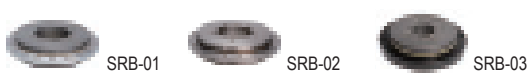

CSB-RPM™转向器支撑套 Steering Rack Bearings P 295-296



KER转角轴承 Knife edge rollers P 290



CSB-PEC™扶梯自润滑回转链 Self-lubricated Rotary Chains P 297-298



CSB-SFP™耐磨半成品 Semi-finished Products P 281-289



CSB-FWB™纤维缠绕轴承 Filament-wound Bearings P 303-315



金属自润滑轴承 Metal Sliding Bearings P 316-317



SRB-01高速型回转支承轴承 SRB-01 High Speed Slewing Ring Bearings



产品特性 Product Features

- 滑动摩擦与滚动摩擦的完美结合
 - 内部采用自润滑材料M80角接触滚动轴承
 - 轴向摩擦片采用EPB7低摩擦系数高耐磨材料
 - 承载的同时转动灵活
 - 使用温度-50℃~+100℃
 - 易安装、免维护
- A perfect combination of sliding and rolling operation
 - The inside part is an angular contact ball bearing made with self-lubricated material M80
 - The axial friction pad is EPB7 material which is with low friction factor and high wearing resistance
 - Smoothly rotation even under heavy load condition
 - Working temperature range: -50℃~+100℃
 - Easy installation and maintenance free

产品技术数据表 Technical data table

项目 Item	单位 Unit	SRB-01-20	SRB-01-30	SRB-01-40	SRB-01-50	SRB-01-60	SRB-01-80	SRB-01-100
重量 Weight	kg	0.2	0.4	0.6	0.9	1.1	1.2	1.3
最大旋转速度 Max. Rotation Speed	r/min	600	550	500	450	400	350	300
最大静载荷 Max. Static Load	轴向 Axial	N	15000	27000	32000	40000	50000	55000
	径向 Radial	N	500	700	800	950	1050	1500
最大动载荷 Max. Dynamic Load	轴向 Axial	N	4000	7000	8000	10000	15000	16000
	径向 Radial	N	350	470	550	600	680	950
最大允许倾覆力矩 Max. Permitted Overturning	Nm	100	200	400	600	800	1200	1500

标准规格 Standard Specifications

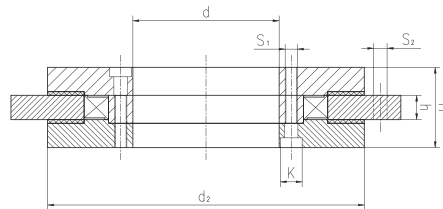
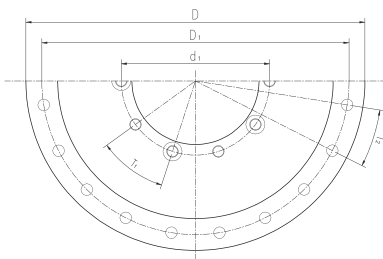

订购编码 Order PN:

SRB-01-20

内径 Inner diameter
系列号 Design No.

订购编码 Order PN	D [mm]	D ₁ [mm]	d ₁ [mm]	d [mm]	d ₂ [mm]	H [mm]	h [mm]	T ₁ [mm]	T ₂ [mm]	S ₁ [mm]	S ₂ [mm]
SRB-01-20	80	70	31	20	60	24	8	8 × 45°	6 × 60°	M4	4.5
SRB-01-30	100	91	42.5	30	82	29	10	10 × 36°	8 × 45°	M4	4.5
SRB-01-40	120	110	53	40	100	30	10	10 × 36°	18 × 20°	M4	4.5
SRB-01-50	150	135	65	50	120	33	10	10 × 36°	20 × 18°	M4	4.5
SRB-01-60	160	145	74	60	130	33	10	10 × 36°	20 × 18°	M5	5.5
SRB-01-80	175	163	92	80	150	33	10	10 × 36°	18 × 20°	M5	5.5
SRB-01-100	185	170	112	100	160	34	12	12 × 30°	16 × 22.5°	M5	5.5

SRB-02高载型回转支撑轴承 SRB-02 High Load Slewing Ring Bearings



产品特性 Product Features

- 滑动膜单元均采用高载低摩擦材料CSB-11
- 内外环均采用优质碳钢表面硬铬处理
- 极高载荷和扭矩
- 使用温度-195~+280℃
- 易安装、免维护
- The Sliding element is a standard CSB-11 bearing with high load and low friction factor
- Inside and outside of the bearing are made with carbon steel and with chrome hard coated
- The part is with extremely high load capacity and torque
- Working temperature range -195℃~+280℃
- Easy installation and maintenance free

产品技术数据表 Technical data table

项目 Item	单位 Unit	SRB-02-20	SRB-02-30	SRB-02-40	SRB-02-50	SRB-02-60	SRB-02-80	SRB-02-100	
重量 Weight	kg	0.5	1.0	1.5	2.5	3.0	3.5	4.0	
最大旋转速度 Max. Rotation Speed	r/min	300	230	190	160	150	130	120	
最大静载荷 Max. Static Load	轴向 Axial	N	60000	170000	280000	340000	380000	450000	480000
	径向 Radial	N	30000	85000	140000	170000	190000	225000	240000
最大动载荷 Max. Dynamic Load	轴向 Axial	N	25000	38000	45000	58000	66000	80000	100000
	径向 Radial	N	12500	19000	22500	29000	33000	40000	50000
最大允许倾覆力矩 Max. Permitted Overturning	Nm	300	600	1500	2000	4000	4500	5000	

标准规格 Standard Specifications

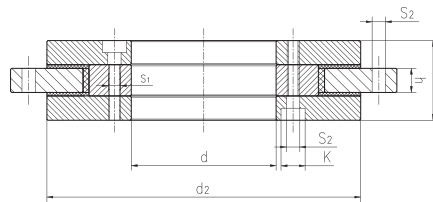
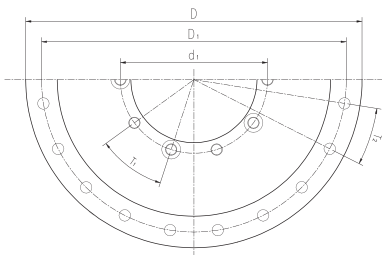

订购编码 Order PN:

SRB-02-20

内径 Inner diameter

系列号 Design No.

订购编码 Order PN	D [mm]	D ₁ [mm]	d ₁ [mm]	d [mm]	d ₂ [mm]	H [mm]	h [mm]	T ₁ [mm]	T ₂ [mm]	S ₁ [mm]	S ₂ [mm]
SRB-02-20	80	70	31	20	60	24	8	3 × 120°	6 × 60°	M4	4.5
SRB-02-30	100	91	42.5	30	82	29	10	8 × 45°	8 × 45°	M4	4.5
SRB-02-40	120	110	53	40	100	30	10	9 × 40°	18 × 20°	M4	4.5
SRB-02-50	150	135	65	50	120	33	10	10 × 36°	20 × 18°	M4	4.5
SRB-02-60	160	145	74	60	130	33	10	10 × 36°	20 × 18°	M5	5.5
SRB-02-80	175	163	92	80	150	33	10	10 × 36°	18 × 20°	M5	5.5
SRB-02-100	185	170	112	100	160	34	12	12 × 30°	16 × 22.5°	M5	5.5

SRB-03回转支承轴承 SRB-03 Slewing Ring Bearings



产品特性 Product Features

- 自润滑、免维护
- 滑动原件采用高耐磨材料EPB13制成
- 回转环表面硬化处理
- 易安装和替换性好
- 可选铝合金或不锈钢304材料
- Maintenance-free, self lubricating
- Sliding elements made of high wear resistance EPB13
- Slewing ring with high stiffening
- Simple installation, replaceable
- Available as aluminum or stainless steel version 304

产品技术数据表 Technical data table

项目 Item	单位 Unit	SRB-03-20	SRB-03-30	SRB-03-40	SRB-03-50	SRB-03-60	SRB-03-80	SRB-03-100	
重量 Weight	kg	0.2	0.4	0.6	0.9	1.1	1.2	1.3	
最大旋转速度 Max. Rotation Speed	r/min	300	250	250	200	200	150	150	
最大静载荷 Max. Static Load	轴向 Axial	N	15000	27000	32000	40000	50000	55000	
	径向 Radial	N	500	700	800	950	1050	1250	1500
最大动载荷 Max. Dynamic Load	轴向 Axial	N	4000	7000	8000	10000	15000	15500	16000
	径向 Radial	N	350	470	550	600	680	800	950
最大允许倾覆力矩 Max. Permitted Overturning	Nm	100	200	400	600	800	1200	1500	

标准规格 Standard Specifications

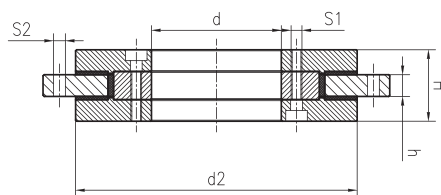
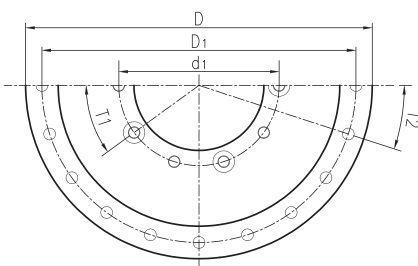

订购编码 Order PN:

SRB-03-20

内径 Inner diameter

系列号 Design No.

订购编码 Order PN	D [mm]	D ₁ [mm]	d ₁ [mm]	d [mm]	d ₂ [mm]	H [mm]	h [mm]	T ₁ [mm]	T ₂ [mm]	S ₁ [mm]	S ₂ [mm]
SRB-03-20	80	70	31	20	60	24	8	6 × 60°	6 × 60°	M4	4.5
SRB-03-30	100	91	42.5	30	82	29	10	8 × 45°	8 × 45°	M4	4.5
SRB-03-40	120	110	53	40	100	30	10	8 × 45°	8 × 45°	M4	4.5
SRB-03-50	150	135	65	50	120	33	10	8 × 45°	16 × 22.5°	M4	4.5
SRB-03-60	160	145	74	60	130	33	10	10 × 36°	20 × 18°	M5	5.5
SRB-03-80	175	163	92	80	150	33	10	10 × 36°	20 × 18°	M5	5.5
SRB-03-100	185	170	112	100	160	34	12	12 × 30°	16 × 22.5°	M5	5.5

CSB-SRB 限位环 Spacing Ring

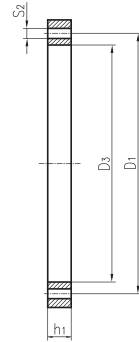
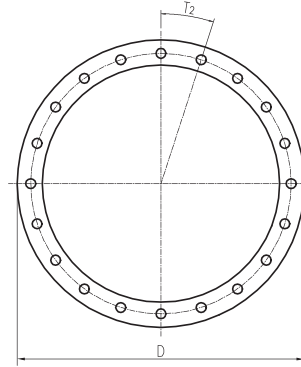
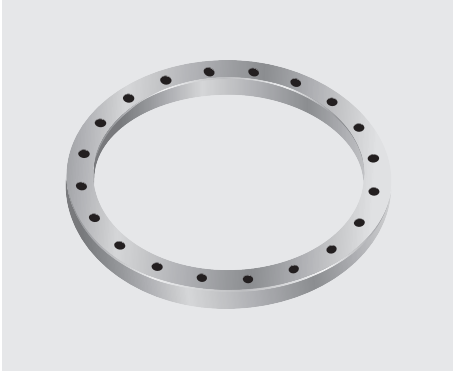

标准规格 Standard Specifications

订购编码 Order PN	订购编码 Order PN	D [mm]	D ₁ [mm]	T ₂ [mm]	S ₂ [mm]	D ₃ [mm]	h ₁ [mm]
SRB-01-20-SR	SRB-02-20-SR	80	70	6 × 60°	4.5	62	12
SRB-01-30-SR	SRB-02-30-SR	100	91	8 × 45°	4.5	84	14
SRB-01-40-SR	SRB-02-40-SR	120	110	18 × 20°	4.5	102	14
SRB-01-50-SR	SRB-02-50-SR	140	130	20 × 18°	4.5	122	14
SRB-01-60-SR	SRB-02-60-SR	160	145	20 × 18°	5.5	132	14
SRB-01-80-SR	SRB-02-80-SR	175	163	18 × 20°	5.5	152	14
SRB-01-100-SR	SRB-02-100-SR	185	170	16 × 22.5°	5.5	162	16

订购编码 Order PN	D [mm]	D ₁ [mm]	T ₂ [mm]	S ₂ [mm]	D ₃ [mm]	h ₁ [mm]
SRB-03-20-SR	80	70	6 × 60°	4.5	62	12
SRB-03-30-SR	100	91	8 × 45°	4.5	84	14
SRB-03-40-SR	120	110	8 × 45°	4.5	102	14
SRB-03-50-SR	140	130	16 × 22.5°	4.5	122	14
SRB-03-60-SR	160	145	20 × 18°	5.5	132	14
SRB-03-80-SR	175	163	20 × 18°	5.5	152	14
SRB-03-100-SR	185	170	16 × 22.5°	5.5	162	16

材料: 硬质阳极氧化铝 Material: Hard-anodized Aluminum

订购编码 Order PN:

SRB-01-20-SR

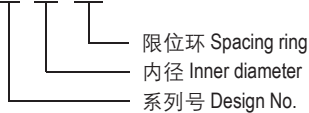

[Http: //www.csb-ep.com](http://www.csb-ep.com)

浙江长盛塑料轴承技术有限公司
地址: 浙江省嘉善惠民街道汾湖路6号
邮编: 314100
Tel: 0573-84186133/84185527
Fax: 0573-84185517
E-mail: sales@csb-ep.com

Zhejiang CSB Plastic Bearing Technology Co.,Ltd.
Add: No.6, Fenhu Road, Huimin Sub-district, Jiashan, Zhejiang, China
Zip Code: 314100
Tel: 0086 573 84185528/84184307
Fax: 0086 573 84183450
E-mail: sales@csb-ep.com

总部: 浙江长盛滑动轴承股份有限公司
地址: 浙江嘉善经济开发区鑫达路6号
Http: //www.csb.com.cn

Zhejiang Changsheng Sliding Bearing Co., Ltd.
Add: No.6 Xinda Road, Economic Development Zone,
Jiashan, Zhejiang, China.

CSB全球 CSB Global

□ CSB in Germany

CSB Gleitlager GmbH
Address: Meierstr. 34 - 36, D-32120
Hiddenhausen
Tel: +49(0)5223-985069-0
Fax: +49(0)5223-985069-20
Web-site: www.csb-gleitlager.de
E-mail: info@csb-gleitlager.de

□ CSB in France

CSB Bearing France
Address: 3, Boulevard Eugene Marie
27800 Brionne, France
Tel: +33-232-433276
Fax: +33-970-063257
Web-site: www.csb-bearings.fr
E-mail: p.mouclier@csb-bearings.fr

□ CSB in UK

KRF UK LTD
Address: 6, Biton Road Rugby, CV22
7AB, UK
Tel: +44-1788 5415551
Fax: +44-1788 541368
Web-site: www.krfukltd.co.uk
E-mail: marksmith@krfukltd.co.uk

□ CSB in Sweden

D&E Tradomg AB
Address: Himmelsbodavagen
9, SE-147 39 Tumba, Sweden
Tel: +46 8 4474050
Fax: +46 8 4474060
Web-site: www.detrading.se
E-mail: johan@detrading.se

□ CSB in Finland

D&E Trading OY
Address: Takasenkatu 55
08150 Lohja, Finland
Tel: +358 207 118670
Fax: +358 207 118678
Web-site: www.detrading.fi
E-mail: deoy@detrading.fi

□ CSB in Turkey

O-Pak Ithalat ve Ihracat Ltd. Sti.
Address: Perpa Ticaret Merkezi A-
Blok Kat 5 No: 282-284-286
okmeydanl 34384 istanbul Turkey
Tel: +90-212-222 57 00 / 221 53 15
Fax: +90-212-222 56 99 / 221 23 18
Web-site: www.o-pak.com.tr
E-mail: a.arevyan@o-pak.com.tr

□ CSB in Switzerland

GGT Gleit-Technik AG
Address: Meierskappelstr. 3, CH-
6403 Kuessnacht am Rigi, Switzerland
Tel: +41-418541530
Fax: +41-418541532
Web-site: www.gleitlager.ch
E-mail: info@gleitlager.ch

□ CSB in Canada(Quebec)

Global Bear Inc.
Address: 2064 Chartier Avenue,
Dorval, Quebec, Canada H9P 1H2
Tel: +1-866-631-1110
(Toll free in North America)
+1-514-631-1110
Fax: +1-514-636-7737
Web-site: www.globalbear.ca
E-mail: sales@globalbear.ca

□ CSB in Canada(Ontario)

Global Bear Inc.
Address: 21601 Matheson Blvd.
Unit 10, Mississauga, Ontario,
Canada L4W 1H9
Tel: +1-877-820-4865
(Toll free in North America)
+1-905-624-0612
Fax: +1-905-624-0612
Web: www.globalbear.ca
E-mail: sales@globalbear.ca

□ CSB in India

CSB Sliding Bearing (India) PVT. LTD.
Address: Akash Deep Building Suite
206, Second Floor 26-A,
Barakkhamba Road New Delhi-110001, India
Tel: +91-11-66302220/21
Fax: +91-11-23715557
Web: www.csbslidingbearings.com
E-mail: info@csbslidingbearings.com

